

Grundfos UPM3 Auto 15/70

INTRODUKSJON

Grundfos UPM3 Auto 15/70 er en kompakt, energisparende og høy-presterende pumpe laget spesielt for OEM-markedet. LK anvender seg av UPM3 Auto i de fleste produkter på grunn av dens gode egenskaper.

Pumpen har ti ulike innstillingsmuligheter: tre kurver for *Proporsjonalt trykk*, tre kurver for *Konstant trykk* og fire kurver for *Konstant kurve*. For gulvvarme anbefales innstillingen *Konstant trykk* og en kurve som er tilpasset installasjonens forutsetninger. Ved levering vil pumpen være stilt inn til *Proporsjonalt trykk*, kurve tre.

DRIFTSMODUS / INNSTILLINGSSMODUS

Grundfos UPM3 Auto viser ved normal drift hvor effektivt hvilken innstilling pumpen jobber i for øyeblikket. Les av hvilket innstillingsmodus som er valgt ifølge oversiktstabellen. For å endre på pumpens innstilling, trykk på knappen på pumpen, til pumpen skifter til valgt innstilling ifølge oversiktstabellen. Ved å trykke på knappen  går pumpen gjennom innstillingsmulighetene. Still inn ønsket modus ifølge tabellen.

Merk at for gulvvarme anbefales konstant trykk (*Constant Pressure*) med en kurve som er tilpasset etter installasjonens behov.

| | | |
|-------------------------------------------------------------------------------------|------------------------|-------------------------------------------------------------------------------------|
|  | CONSTANT PRESSURE 1 |  |
|  | CONSTANT PRESSURE 2 |  |
|  | CONSTANT PRESSURE-3MAX |  |

Tabell, oversikt driftsmodus.











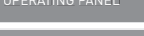











OBS!
Ved levering vil pumpen være innstilt til *Proporsjonalt trykk*, kurve tre. Dette må endres på manuelt til *Konstant trykk* av installatøren, når pumpen skal anvendes i gulvvarmeinstallasjoner.



INNHALDSFORTEGNELSE

| | |
|---------------------------------|---|
| Instruksjon | 1 |
| Driftsmodus - Innstillingsmodus | 1 |
| Oversiktstabell | 2 |
| Alarmkoder | 2 |
| Dimensjoner | 2 |
| Pumpediagram | 2 |
| Elektrisk kontakt | 2 |

OVERSIKTSTABELL

| | OPERATING PANEL | CONTROL MODE | |
|----|--------------------------------------------------------------------------------------|----------------------------------|---------------------------------------------------------------------------------------|
| 0 |  | PROPORTIONAL PRESSURE AUTO ADAPT |  |
| 1 |  | CONSTANT PRESSURE AUTO ADAPT |  |
| 2 |  | PROPORTIONAL PRESSURE 1 |  |
| 3 |  | PROPORTIONAL PRESSURE 2 |  |
| 4 |  | PROPORTIONAL PRESSURE 3 - MAX |  |
| 5 |  | CONSTANT PRESSURE 1 |  |
| 6 |  | CONSTANT PRESSURE 2 |  |
| 7 |  | CONSTANT PRESSURE-3MAX |  |
| 8 |  | CONSTANT CURVE 1 |  |
| 9 |  | CONSTANT CURVE 2 |  |
| 10 |  | CONSTANT CURVE 3 - MAX |  |

Oversikt over innstillingsmuligheter for UPM3. Relevante innstillinger er markert med en blå trekant, andre innstillingsmuligheter vises i en tonet ned farge.

ALARMKODER

Om driftsproblemer skulle oppstå vises en feilkode, slik som vist nedenfor.

| Skjerm | Indikasjon | Drift | Handling |
|-------------------------|-----------------------------|--------------------------------------------------------------------|------------------------------------------------------------|
| En Rød LED, Gul LED #5. | Rotor blokkert | Startforsøk var 1,33 s. | Stans eller frigjør rotor |
| En Rød LED, Gul LED #4. | For lav spennings-tilførsel | Kun en advarsel, pumpen fungerer som normalt | Kontroller spenning til pumpe |
| En Rød LED, Gul LED #3. | Elektronisk feil | Pumpe stanset pga. for lav spennings-tilførsel eller alvorlig feil | Kontroller spenning til pumpe / skift ut pumpe/ pumpehjul* |

* Frigjør pumpehjul ved hjelp av en skrutrekker PH2. Bryt spenning til pumpen. Sett inn skrutrekker i senterhullet på driosiden, trykk inn skrutrekkeren ca. 5 mm, vri deretter frem/tilbake til pumpehjulet løsner.

DIMENSJONER

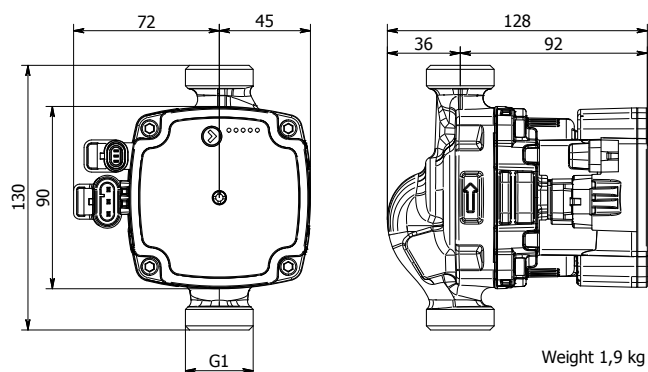

Grundfos UPM3 Auto 15/70 130

PUMPEDIAGRAM

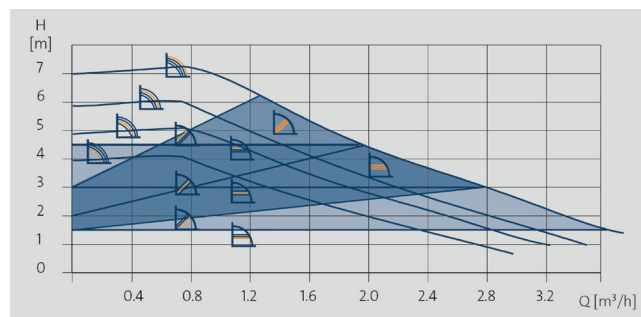

ELEKTRISK KONTAKT

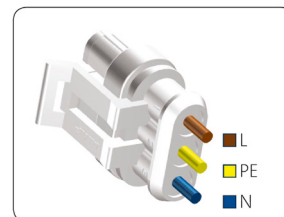
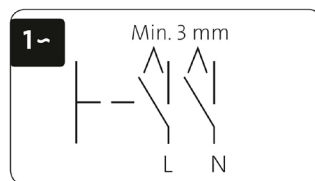

Pumpens kontakt kobles til 230 V, 50 Hz av en profesjonell elektriker, ifølge skjema overfor. Kontakten erstatter krav om 2-pols arbeidsbrytere. Den elektriske tilkoblingen skal sikres med maksimum 10 A treg sikring. Pumpen skal gjøres spenningsfri ved eventuelt vedlikeholdsarbeid.

