

# Grundfos UPM3 Auto 15/70

## INTRODUKSJON



Grundfos UPM3 Auto 15/70 er en kompakt, energisparende og høy-presterende pumpe laget spesielt for OEM-markedet. LK anvender seg av UPM3 Auto i de fleste produkter på grunn av dens gode egenskaper.

Pumpen har ti ulike innstillingsmuligheter: tre kurver for *Proporsjonalt trykk*, tre kurver for *Konstant trykk* og fire kurver for *Konstant kurve*. For gulvvarme anbefales innstillingen *Konstant trykk* og en kurve som er tilpasset installasjonens forutsetninger. Ved levering vil pumpen være stilt inn til *Proporsjonalt trykk*, kurve tre.

## DRIFTSMODUS / INNSTILLINGSSMODUS

Grundfos UPM3 Auto viser ved normal drift hvor effektivt hvilken innstilling pumpen jobber i for øyeblikket. Les av hvilket innstillingsmodus som er valgt ifølge oversiktstabellen. For å endre på pumpens innstilling, trykk på knappen på pumpen, til pumpen skifter til valgt innstilling ifølge oversiktstabellen. Ved å trykke på knappen  går pumpen gjennom innstillingsmulighetene. Still inn ønsket modus ifølge tabellen.

Merk at for gulvvarme anbefales konstant trykk (*Constant Pressure*) med en kurve som er tilpasset etter installasjonens behov.

	CONSTANT PRESSURE 1	
	CONSTANT PRESSURE 2	
	CONSTANT PRESSURE-3 MAX	

Tabell, oversikt driftsmodus.



### OBS!























Ved levering vil pumpen være innstilt til *Proporsjonalt trykk*, kurve tre. Dette må endres på manuelt til *Konstant trykk* av installatøren, når pumpen skal anvendes i gulvvarmeinstallasjoner.

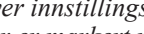

## INNHALDSFORTEGNELSE

Instruksjon	1
Driftsmodus - Innstillingsmodus	1
Oversiktstabell	2
Alarmkoder	2
Dimensjoner	2
Pumpediagram	2
Elektrisk kontakt	2

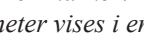
## OVERSIKTSTABELL

	OPERATING PANEL	CONTROL MODE	
0		PROPORTIONAL PRESSURE AUTO ADAPT	
1		CONSTANT PRESSURE AUTO ADAPT	
2		PROPORTIONAL PRESSURE 1	
3		PROPORTIONAL PRESSURE 2	
4		PROPORTIONAL PRESSURE 3 - MAX	
5		CONSTANT PRESSURE 1	
6		CONSTANT PRESSURE 2	
7		CONSTANT PRESSURE-3 MAX	
8		CONSTANT CURVE 1	
9		CONSTANT CURVE 2	
10		CONSTANT CURVE 3 - MAX	

Oversikt over innstillingsmuligheter for UPM3. Relevante innstillinger er markert med en blå trekant, andre innstillingsmuligheter vises i en tonet ned farge.

## ALARMKODER

Om driftsproblemer skulle oppstå vises en feilkode, slik som vist nedenfor.

Skjerm	Indikasjon	Drift	Handling
En Rød LED, Gul LED #5.	Rotor blokkert	Startforsøk var 1,33 s.	Stans eller frigjør rotor
En Rød LED, Gul LED #4.	For lav spennings-tilførsel	Kun en advarsel, pumpen fungerer som normalt	Kontroller spenning til pumpe
En Rød LED, Gul LED #3.	Elektronisk feil	Pumpe stanset pga. for lav spennings-tilførsel eller alvorlig feil	Kontroller spenning til pumpe / skift ut pumpe/ pumpehjul*

\* Frigjør pumpehjul ved hjelp av en skrutrekker PH2. Bryt spenning til pumpen. Sett inn skrutrekker i senterhullet på drifisiden, trykk inn skrutrekkeren ca. 5 mm, vri deretter frem/tilbake til pumpehjulet løsner.

## DIMENSJONER

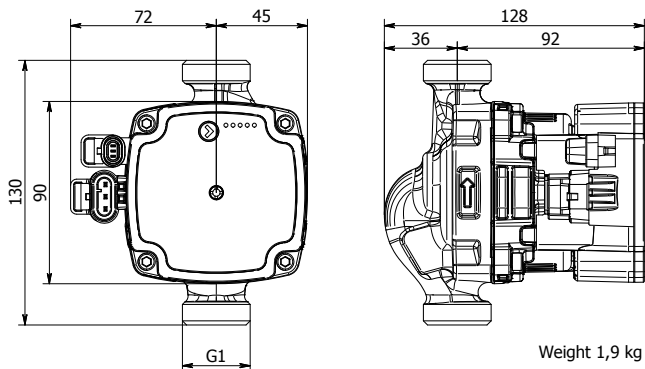

Grundfos UPM3 Auto 15/70 130

## PUMPEDIAGRAM

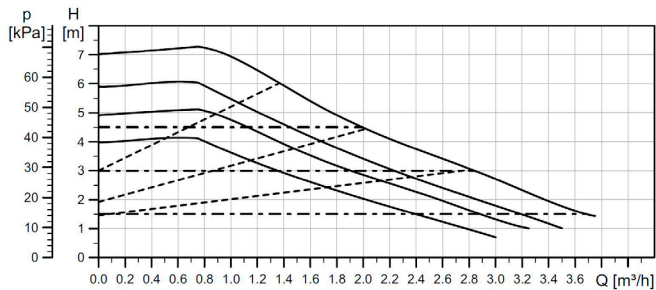

## ELEKTRISK KONTAKT

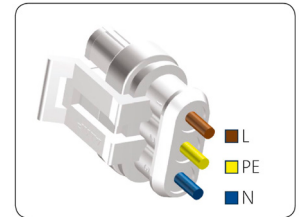
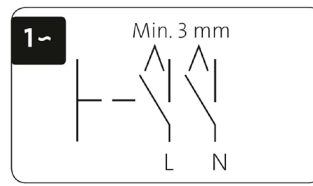

Pumpens kontakt kobles til 230 V, 50 Hz av en profesjonell elektriker, ifølge skjema overfor. Kontakten erstatter krav om 2-pols arbeidsbrytere. Den elektriske tilkoblingen skal sikres med maksimum 10 A treg sikring. Pumpen skal gjøres spenningsfri ved eventuelt vedlikeholdsarbeid.

